

Panasonic®

Operating Instructions/Bedienungsanleitung/ Mode d'emploi/Istruzioni per l'uso/ Instrucciones de funcionamiento/ 操作手冊/取扱説明書

Remote Control Unit/Fernsteuereinheit/ Module de télécommande/ Unità per il comando a distanza/Unidad de control remote/ 摄像机遥控器 / リモートコントロールユニット

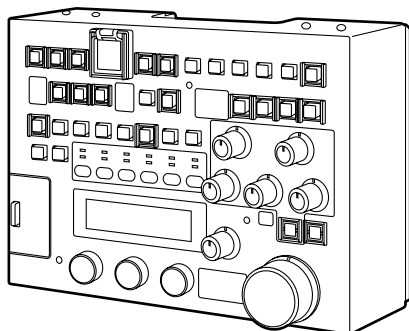

Model No. AJ-RC10G



Before operating this product, please read the instructions carefully and save this manual for future use.

Bitte lesen Sie vor Inbetriebnahme dieses Produkts die Anleitungen sorgfältig durch und bewahren Sie dieses Handbuch für spätere Verwendung auf.

Avant de vous servir de ce produit, veuillez lire attentivement les instructions et enregistrer ce manuel pour une utilisation ultérieure.

Prima di utilizzare questo prodotto, leggere attentamente le istruzioni di questo manuale e conservarlo per riferimento futuro.

Antes de poner este producto en funcionamiento, lea atentamente las instrucciones y conserve este manual para uso futuro.

使用前产品前, 请仔细阅读本说明书, 并妥善保存以备日后参考。

お買い上げいただき、まことにありがとうございました。

この取扱説明書をよくお読みの上、正しくお使いください。

特に「安全上のご注意」は、ご使用前に必ずお読みいただき、安全にお使いください。

お読みになったあとは、保証書と一緒に大切に保管し、必要なときにお読みください。

Read this first!

For General

■ DO NOT REMOVE PANEL COVERS BY UNSCREWING THEM.

To reduce the risk of electric shock, do not remove the covers. No user serviceable parts inside. Refer servicing to qualified service personnel.

WARNING:

- TO REDUCE THE RISK OF FIRE OR SHOCK HAZARD, DO NOT EXPOSE THIS EQUIPMENT TO RAIN OR MOISTURE.
- TO REDUCE THE RISK OF FIRE OR SHOCK HAZARD, KEEP THIS EQUIPMENT AWAY FROM ALL LIQUIDS. USE AND STORE ONLY IN LOCATIONS WHICH ARE NOT EXPOSED TO THE RISK OF DRIPPING OR SPLASHING LIQUIDS, AND DO NOT PLACE ANY LIQUID CONTAINERS ON TOP OF THE EQUIPMENT.

CAUTION:

TO REDUCE THE RISK OF FIRE OR SHOCK HAZARD AND ANNOYING INTERFERENCE, USE THE RECOMMENDED ACCESSORIES ONLY.

CAUTION:

In order to maintain adequate ventilation, do not install or place this unit in a bookcase, built-in cabinet or any other confined space. To prevent risk of electric shock or fire hazard due to overheating, ensure that curtains and any other materials do not obstruct the ventilation.



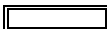

Note:

The rating plate is on the underside of the unit.

 indicates safety information.

Read this first! (Continued)

For USA

	CAUTION RISK OF ELECTRIC SHOCK DO NOT OPEN	
CAUTION: TO REDUCE THE RISK OF ELECTRIC SHOCK, DO NOT REMOVE COVER (OR BACK). NO USER SERVICEABLE PARTS INSIDE. REFER TO SERVICING TO QUALIFIED SERVICE PERSONNEL.		
	The lightning flash with arrowhead symbol, within an equilateral triangle, is intended to alert the user to the presence of uninsulated "dangerous voltage" within the product's enclosure that may be of sufficient magnitude to constitute a risk of electric shock to persons.	
	The exclamation point within an equilateral triangle is intended to alert the user to the presence of important operating and maintenance (service) instructions in the literature accompanying the appliance.	
FCC Note: This equipment has been tested and found to comply with the limits for a class A digital device, pursuant to Part 15 of the FCC Rules. These limits are designed to provide reasonable protection against harmful interference when the equipment is operated in a commercial environment. This equipment generates, uses, and can radiate radio frequency energy, and if not installed and used in accordance with the instruction manual, may cause harmful interference to radio communications. Operation of this equipment in a residential area is likely to cause harmful interference in which case the user will be required to correct the interference at his own expense.		
Warning: To assure continued FCC emission limit compliance, the user must use only shielded interface cables when connecting to external units. Also, any unauthorized changes or modifications to this equipment could void the user's authority to operate it.		

 indicates safety information.

Table of Contents

Read this first!	1	Menu item	24
General	4	Menu	24
Features	4	BLACK.....	24
Accessories	4	FLARE.....	25
Connection	5	GAMMA.....	25
System configuration	5	WHITE.....	25
Parts and functions	6	KNEE.....	27
Front panel	6	SHUTTER	27
Rear panel.....	15	SHAD	28
Basic operations	16	MATRIX.....	28
When the power is on.....	16	DTL.....	29
To enable the buttons/volumes	16	SKIN DTL	29
To disable buttons/volumes.....	16	FUNC	30
Operation of the camera recorder ...	17	SYSTEM.....	31
Operation of the camera		Connection cable	32
using the unit volume	18	Confirmation of software	
Operation of the scene file	19	version	32
Operation for recording	20	Specifications	33
Saving/Loading of scene files onto			
the SD memory card	21		
Handling methods			
for the SD memory card	21		
To load data from the card	21		
To write data on the card.....	22		
To delete files from the card.....	22		
Initialization of the card.....	22		
Menu operation	23		
Operations using the LCD panel	23		
Operation of the camera recorder			
menu	23		
Adjustment of functions			
on the unit.....	23		

General

The AJ-RC10G (hereinafter called “the unit”) is a remote control unit connected to the camera recorder. The unit controls the camera recorder from the controller and is capable of changing numerical values in the menu. Coverage can be extended by 50m by using the dedicated cable.

Features

- For some frequently functions on the camera unit, dedicated switches are provided for direct operation.
- By switching to the recorder mode, the camera recorder can be controlled directly through the VTR operation switch. In addition, recording can be disabled using a switch.
- Frequently used menus can be set by accessing the menus on the LCD panel of the unit. It is also possible to display the time code on the LCD panel.
- Down-converted images with characters are output from the VIDEO OUT connector. The menus can be operated on the main unit of the camera recorder by connecting the external monitor.
- By switching to the scene file mode, it is possible to operate the scene file. Data of revised scene files can be stored on an SD memory card.

Accessories

Connection cable (10 m)

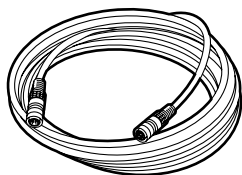

Connection

- 1** While the power supply of the camera recorder is turned off, connect the RCU 10-pin connector of the camera recorder to the unit with the connection cable.
If settings are made from the camera menu, set the frequency to the frame frequency of the camera recorder and connect an NTSC or PAL monitor.
- 2** After turning on the camera recorder power, turn the unit power on.

<Notes>

- The frame frequency of the camera recorder must be switched before connecting the unit to the camera recorder.
At VIDEO output, NTSC signals are output for 60 Hz operation, while PAL signals are output for 50 Hz operation.
- The settings for FUNC on the menu determine whether the camera recorder's settings, which are adjusted when the unit is connected, are returned to the settings before connecting the unit or to the state after adjustment, when the unit is disconnected from the camera recorder.
- Do not forcefully pull the connected cable.
When the camera recorder is used while it is being moved, the cable must be fixed to the tripod or the handle of the camera recorder so that no force is applied directly to the connector.

System configuration

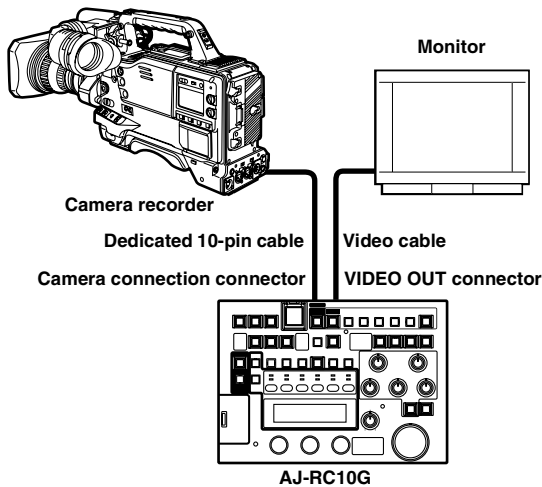

<Note>

To determine whether the camera recorder supports the use of the unit, consult our sales dealers or the operation manual of the camera recorder.

Parts and functions

Front panel

Panel part

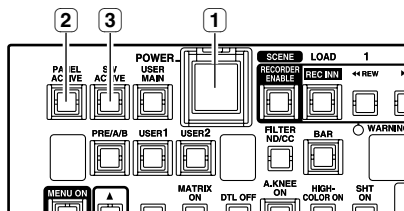

1 POWER button

ON/OFF switch of the main power supply of the main unit

2 PANEL ACTIVE button

For controlling which panel operations are available

When the lamp is on:

The panel operations are available.

When the power is on, the unit is on.

When the lamp is off:

Only the POWER button and the PANEL ACTIVE button are available; all other button operations are disabled.

Turning on the self-lighting buttons and the LED display, which indicate the operating conditions of the camera recorder, follow the operating conditions of the camera recorder.

3 SW ACTIVE button

For enabling button/switch operations

When the lamp is on:

The button/switch operations are enabled.

When the lamp is off:

Only the POWER button, PANEL ACTIVE button, SW ACTIVE button, VR ACTIVE button, AUTO IRIS button, M.PED volume, and IRIS volume are available; all other operations are disabled.

Turning on the self-lighting SW and the LED display, which indicate the operating conditions of the camera recorder, follow the operating conditions of the camera recorder.

Parts and functions (Continued)

Camera recorder/Scene file operation

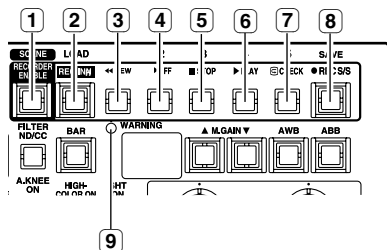

1 RECORDER ENABLE button

For switching between the recorder mode and the scene file mode

When the lamp is on:

Recorder mode

Buttons from 3 to 8 are operated as control buttons for the recording.

When the lamp is off:

Scene file mode

Buttons from 3 to 8 are operated as the buttons for reading and storing scene files. When the power is turned on, the unit is in this state.

2 REC.INH/LOAD button

In recorder mode:

When the lamp is on, the REC S/S button 8 is inhibited.

However, even if the unit is in the recording inhibition state, operation of the USER button assigned REC function and operation of the REC button on the camera recorder are enabled.

The lamp is off when the power is on.

In scene file mode:

The button is operated as the LOAD switch of the scene file. Data are retrieved from the file on the remote controller.

3 REW/1 button

In recorder mode:

This button is operated in the same way as the REW button on the camera recorder, and the lamp is on when a tape is rewinding.

In the scene file mode:

1 is selected as the number for the scene file to be saved or loaded.

4 FF/2 button

In recorder mode:

This button is operated in the same way as the FF button on the camera recorder, and the lamp is on when a tape is fast-forwarding.

In scene file mode:

2 is selected as the number for the scene file to be saved or loaded.

5 STOP/3-button

In recorder mode:

This button is operated in the same way as the STOP button on the camera recorder, and the lamp is on when a tape stops.

In scene file mode:

3 is selected as the number for the scene file to be saved or loaded.

6 PLAY/4-button

In recorder mode:

This button is operated in the same way as the PLAY button on the camera recorder, and the lamp is on when a tape is replayed. If the button is pressed again during tape replay, it changes to replay/pause, and the lamp flashes.

If the button is pressed one more time, the unit returns to replaying, and the lamp is on continuously.

In scene file mode:

4 is selected as the number for the scene file to be saved or loaded.

Parts and functions (Continued)

7 CHECK/5-button

In recorder mode:

This is the recording confirmation button. If the button is pressed when recording is paused, the recording can be checked.

The lamp flashes when the tape is rewound and is turned on when the tape is replayed.

In scene file mode:

5 is selected as the number for the scene file to be saved or loaded.

8 REC S/S / SAVE button

In recorder mode:

This is the start/stop button for recording.

This button is operated in the same way as the REC START button on the camera recorder, and the lamp is on during recording.

In scene file mode:

This button is operated in the same way as the SAVE button for scene data.

The current data are stored in the file on the remote controller, which is selected by using the buttons from 3 to 7.

9 RECORDER WARNING lamp

This lamp flashes or is turned on when an error occurs on the camera recorder, just like the WARNING lamp on the camera recorder. For details, refer to the operation manual of the camera recorder.

Parts and functions (Continued)

Basic camera operations

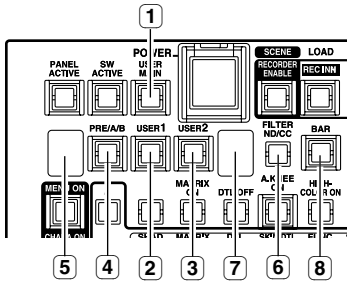

1 USER MAIN button

This button has the same function as the USER MAIN switch on the camera recorder. The lamp is on only when the button is pressed.

<Note>

Functions assigned to the USER MAIN button are selected in the menu of the camera recorder or the unit.

2 USER1 button

This button has the same function as the USER1 switch on the camera recorder. The lamp is on only when the button is pressed.

<Note>

Functions assigned to the USER1 button are selected in the menu of the camera recorder or the unit.

3 USER2 button

This button has the same function as the USER2 switch on the camera recorder. The lamp is on only when the button is pressed.

<Note>

Functions assigned to the USER2 button are selected in the menu of the camera recorder or the unit.

4 PRE/A/B button

Operations of this button are the same as for the WHITE BAL switch on the camera recorder to select PRE, A or B. The state will switch to “PRE” → “A” → “B” → “PRE” step by step every time the button is pressed.

When the power is turned on, the unit is in the state it was before turning off the power.

5 PRE/A/B display

This displays the WHITE BAL selection on the camera recorder using P/A/b

6 FILTER ND/CC button

This switches the FILTER display on the CC/ND display (7) between ND filter and the CC filter alternately.

7 CC/ND Display

This displays the ND or CC selection using the FILTER ND/CC (6) button.

For the ND filter display, the filter position is indicated with 1/2/3/4.

For the CC filter display, the filter position is indicated with A/b/C/d.

For the single filter, filter switching is disabled. 1/2/3/4 is displayed depending on the filter position.

When the power is on, the ND filter position is displayed.

8 BAR ON/OFF button

This button switches the output from the camera recorder between the color bar and the camera signals.

When the output from the camera recorder is the color bar, the lamp is on; otherwise, it is off.

When the power is turned on, the unit is in the state it was before turning off the power.

Parts and functions (Continued)

Basic camera operations (Continued)

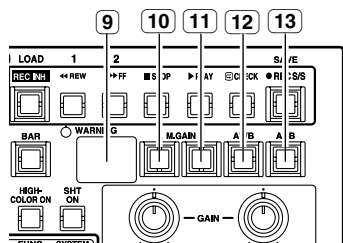

9 GAIN display

This displays the image gain of the camera recorder. The initial value is the gain value at the time when the GAIN switch on the camera recorder was set to "L".

10 M.GAIN ▲ button

When this button is pressed, the image gain of the camera recorder is increased. The lamp is on only when this button is pressed.

11 M.GAIN ▼ button

When this button is pressed, the image gain of the camera recorder is reduced. The lamp is on only when this button is pressed.

12 AWB button

When this button is pressed, the camera recorder starts the AWB (Auto White Balance) operation.

When this button is pressed during AWB operation, the AWB operation will forcibly terminate.

The lamp is on during AWB operation and off when the operation is completed correctly. If AWB operation finishes incorrectly, the lamp will flash for 5 seconds and then turn off.

13 ABB button

When this button is pressed, the camera recorder starts the ABB (Auto Black Balance) operation.

When this button is pressed during the ABB operation, the ABB operation will forcibly terminate.

The lamp is on during ABB operation and off when the operation is completed correctly. If the ABB operation finishes incorrectly, the lamp will flash for 5 seconds and then turn off.

Parts and functions (Continued)

Basic camera operations (Continued)

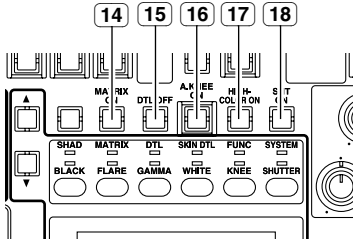

14 MATRIX ON button

This button switches the matrix function ON/OFF. Even if the MATRIX is set to “OFF” in the menu of the camera recorder, it switches to “ON” when this button is pressed. “A” and “B” of the MATRIX TABLE and the settings for the table can be set with the menu on the unit.

The lamp is on when the MATRIX is ON; otherwise, the lamp is off.

15 DTL OFF button

This button switches the DETAIL function of the camera recorder ON/OFF. Even if the DTL item in the menu of the camera recorder is set to “OFF,” it will turn on when this button is pressed.

When the unit is connected to the camera recorder, this becomes the menu value for the camera recorder.

The lamp is on when the DETAIL is set to OFF; otherwise, the lamp is off.

16 A.KNEE ON button

This button switches the AUTO KNEE function ON/OFF. If the AUTO KNEE SW is set to “OFF” in the menu of the camera recorder, it is impossible to turn it ON using this button.

When the power is turned on, the unit is in the state it was before turning off the power. The lamp is on when the AUTO KNEE function is ON; otherwise, the lamp is off.

17 HIGH COLOR ON button

This button switches the HIGH COLOR function ON/OFF. Even if the HIGH COLOR is set to “OFF” in the menu of the camera recorder, it will turn on when this button is pressed.

When the unit is connected to the camera recorder, this becomes the menu value of the camera recorder.

The lamp is on when the HIGH COLOR function is on; otherwise, the lamp is off.

18 SHT ON button

This button switches the shutter function ON/OFF.

The shutter speed, when this function is on, is selected in the menu of the unit.

The lamp is on when the shutter function is on; otherwise, the lamp is off.

When the power is turned on, the unit is in the state it was before turning off the power.

Parts and functions (Continued)

Volume settings

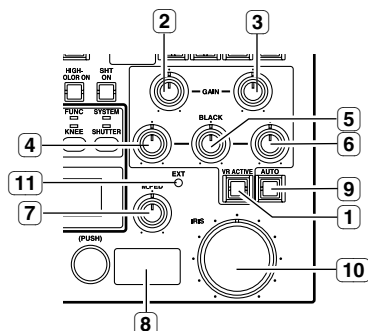

- 1 VR ACTIVE button**
This is a button to approve/inhibit operations of the GAIN volumes from **2** to **3** and the BLACK volumes from **4** to **6**. When the power of the unit is on, it inhibits operations. The lamp is on when the approving/operations are activated; otherwise, the lamp is off.
- 2 R GAIN volume**
This adjusts the Rch gain. The absolute value/relative value mode can be switched in the GAIN-VR-MODE item of the WHITE menu of the unit. When reading card data and scene file data, this will be in the relative value mode. The operations for the B GAIN volume are the same.
- 3 B GAIN volume**
This adjusts the Bch gain.
- 4 R BLACK volume**
This adjusts the Rch black level. Switching between the relative value mode and the absolute value mode is executed in the menu BLACK-VR-MODE of the unit. When reading card data and scene file data, this will be in the relative value mode. It is possible to select either Flare or Pedestal for item adjustment in the Menu BLACK-VR-CONTROL item on the unit. The operations for the G BLACK volume and B BLACK volume are the same.
- 5 G BLACK volume**
This adjusts the Gch black level.
- 6 B BLACK volume**
This adjusts the Bch black level.
- 7 M.PED volume**
This adjusts the master pedestal level. The adjustment range is between the minimum value of -200 and the maximum value of +200 with a center value of 0.
- 8 IRIS display**
This displays the iris of the camera.
- 9 AUTO IRIS button**
This turns on the auto iris function. When the power is turned on, the unit is in the state it was before turning off the power. The lamp is on when the unit commands the auto iris operation in the camera; otherwise, the lamp is off.
- 10 IRIS volume**
This adjusts the iris of the camera. When the AUTO IRIS button **9** is set to OFF, it is possible to move the iris from CLOSE to OPEN by turning this to the right.
- 11 EXT alarm lamp**
This lamp is on when the lens extender is inserted.

Parts and functions (Continued)

Menu operation of the unit

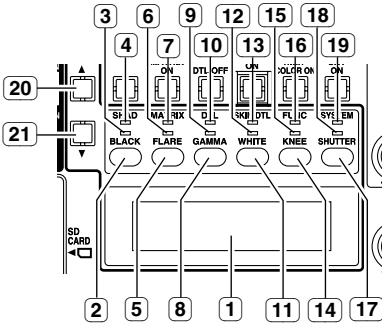

1 LCD panel

This displays the menus for items selected with the menu operation buttons **2**, **5**, **8**, **11**, **14** and **17**. This is also capable of displaying the time code.

2 BLACK/SHAD button

This selects the large item displayed on the LCD panel. The display will switch to BLACK → SHAD → before entering into the menu mode → BLACK step by step every time the button is pressed.

3 BLACK lamp

This lamp is on when BLACK is selected on the LCD panel.

4 SHAD lamp

This lamp is on when SHAD is selected on the LCD panel.

5 FLARE/MATRIX button

This button selects the large item displayed on the LCD panel. The display will switch to FLARE → MATRIX → before entering into the menu mode → FLARE step by step every time the button is pressed.

6 FLARE lamp

This lamp is on when FLARE is selected on the LCD panel.

7 MATRIX lamp

This lamp is on when MATRIX is selected on the LCD panel.

8 GAMMA/DTL button

This selects the large item displayed on the LCD panel. The display will switch to GAMMA → DTL → before entering the menu mode → GAMMA step by step every time the button is pressed.

9 GAMMA lamp

This lamp is on when GAMMA is selected on the LCD panel.

10 DTL lamp

This lamp is on when DTL is selected on the LCD panel.

11 WHITE/SKIN DTL button

This selects the large item displayed on the LCD panel. The display will switch to WHITE → SKIN DTL → before entering the menu mode → WHITE step by step every time the button is pressed.

12 WHITE lamp

This lamp is on when WHITE is selected on the LCD panel.

13 SKIN DTL lamp

This lamp is on when SKIN DTL is selected in on the LCD panel.

Parts and functions (Continued)

14 KNEE/FUNC button

This selects the large item displayed on the LCD panel. The display will switch to KNEE → FUNC → before entering the menu mode → KNEE step by step every time the button is pressed.

15 KNEE lamp

This lamp is on when the KNEE is selected on the LCD panel.

16 FUNC lamp

This lamp is on when the FUNC is selected on the LCD panel.

17 SHUTTER/SYSTEM button

This selects the large item displayed on the LCD panel. The display will switch to SHUTTER → SYSTEM → before entering the menu mode → SHUTTER step by step every time the button is pressed.

18 SHUTTER lamp

This lamp is on when the SHUTTER is selected on the LCD panel.

19 SYSTEM lamp

This lamp is on when the SYSTEM is selected on the LCD panel.

20 ▲ button

21 ▼ button

This button switches the display on the LCD panel and selects a medium item from the menu of the unit.

The lamp is on when the button is pressed and off when the button is released.

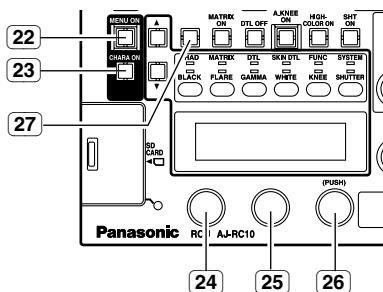

22 MENU ON button

To open the menu on the camera recorder, press this button continuously for 3 seconds. In this case, a message “CAMERA MENU OPEN” is displayed on the LCD panel. The lamp is on at this time, and operations of the menu and the scene file on the unit are not available.

If this button is pressed when the menu of the camera recorder is open, the menu will close.

23 CHARA ON button

This selects whether any characters are overlaid on the video signals output from the VIDEO OUT connector of the unit.

When the power is on, the unit is in the state it was before turning off the power.

The lamp is on when characters are loaded onto the signals, while it is off when characters are not loaded.

24 Rotary encoder 1

25 Rotary encoder 2

26 Rotary encoder 3

This is used for operating the menu on the LCD panel or the camera menu.

The camera menu is operated by using the right rotary encoder.

The operation of the rotary encoder is the same as the JOG switch on the camera (+, -, PUSH)

27 Vacant button

This is a vacant button for which no function is assigned.

Parts and functions (Continued)

Rear panel

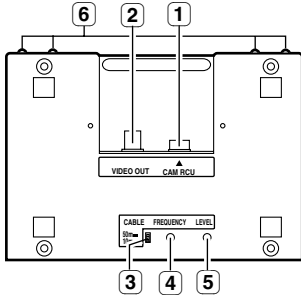

1 Camera connection connector

To connect the 10-pin camera control cable.

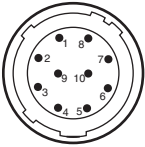

Pin No.	Signal
1	CAM DATA (H)
2	CAM DATA (C)
3	CAM CONT (H)
4	CAM CONT (L)
5	ECU_ON
6	Video input
7	GND (Video)
8	Standby
9	+12 V (IN)
10	GND

2 VIDEO OUT connector

An NTSC or PAL monitor is connected for operating the menu on the main unit of the camera recorder.

3 Cable length selector switch

This switch is on for a 50 m cable.

4 Frequency characteristics adjustment volume

This adjusts the frequency characteristics of the VIDEO signals.

5 Level adjustment volume

This adjusts the level of the VIDEO signals.

6 Covering screw

The unit can be used when the four screws are removed. However, do not leave the unit without these screws for long periods of time. When the screws are not in use, they must be stored safely.

<Note>

Do not remove the four screws on the back panel.

Basic operations

When the power is on

When the POWER button is pressed, the lamp for the PANEL ACTIVE button is on, and the settings of the camera recorder are read into the unit.

The respective numerical values are displayed on the PRE/A/B display, CC/ND display, GAIN display, and the IRIS display, while R GAIN and B GAIN are displayed on the LCD panel.

In this case, only the PANEL ACTIVE button, the SW ACTIVE button, the VR ACTIVE button, the AUTO IRIS button, M.PED volume and the IRIS volume can be operated from the unit, while other buttons and volumes are not operative.

However, the settings on the A.KNEE ON button, the SHT ON button, the AUTO IRIS button, the BAR ON/OFF button and the CHARA ON button will be in the states that had been set on the unit at the last time.

To enable the buttons/volumes

When the SW ACTIVE button is pressed and the lamp is on, button operations are enabled.

1) Operations of the camera part

When the SW ACTIVE button is pressed, operations of the USER MAIN button, GAIN and the camera recorder such as storing scene files in the built-in memory or reading them out, are enabled.

When the SW ACTIVE button is pressed again, the lamp is turned off and button operations are inhibited, while the state of settings that have already been set previously is remained as it is.

2) Operation of the recording part

When the lamp of the RECORDER ENABLE button is turned off, operations of the recording part are disabled. Turn on the lamp of the RECORDER ENABLE button by pressing the button, and then operate the buttons of "PLAY", "FF" or "REW".

To record signals, operate the REC S/S button.

3) To display numerical values on the LCD panel

The GAIN volume is displayed when the power is on.

If the button operations are enabled, it is possible to switch the displayed GAIN volume → BLACK volume → a numerical value for M/PED → TC step-by-step by using the ▲ button and the ▼ button.

When volume operation is enabled, the volume level is forcibly displayed if the GAIN volume or the BLACK volume is operated. However, it is possible to return the screen to the state before operating the GAIN volume or the BLACK volume by pressing the Rotary Encoder 3.

<Note>

It is impossible to switch the display when the unit menu or the camera menu is operating. The volume level is not displayed even if the volume is operated.

To disable buttons/volumes

If the lamp of the PANEL ACTIVE button is turned off, operations using the buttons and the volume on the panel are inhibited.

If the lamp of the VR ACTIVE button is turned off by pressing the button, setting the GAIN and BLACK using the volume controls is inhibited.

Use this feature if you intend to retain the settings. However, note that if the volume is moved when inhibited, the volume level change will be reflected immediately after turning on the lamp of the PANEL ACTIVE button and/or the VR ACTIVE button by pressing the button again.

<Note>

It is possible for the GAIN and the BLACK to avoid changes in the volume position during the inhibition by setting the volume mode on the unit menu to a relative value (REL).

Basic operations (Continued)

Operation of the camera recorder

1) Operation of the display interlocking switch

Select the white balance settings by using the PRE/A/B button and monitoring the PRE/A/B display.

The state of the camera recorder filter is displayed on the CC/ND display.

If two filters are installed on the camera recorder, it is impossible to switch the filters from the unit but it is possible to switch the display by using the FILTER ND/CC button.

The ND filter is indicated with numerical values while the CC filter is indicated with letters of the alphabet.

The gain will change when using the two buttons of the M.GAIN▲ button and M.GAIN▼ button and monitoring the GAIN display.

However, if super gain is set to ON in the USER switch, operations of the MGAIN button are disabled.

2) Operation of the USER switch

The USER MAIN/USER1/USER2 switch functions the same as the USER switch on the camera recorder. Functions of the USER switch can be set and confirmed on the camera menu or the USER-SW item on the unit menu.

3) Operation of the ABB/AWB/BAR switch

The ABB button and the AWB button function the same as the switch for the white balance/black balance of the camera recorder.

The lamp is on when the unit is operated.

If the button is pressed again during operation, the lamp will flash for 5 seconds to indicate an interruption of the operation.

If "PRE" is selected in the PRE/A/B selection of the white balance, it is impossible to change the setting, and the lamp will flash for 5 seconds.

The BAR button switches the camera output to the color bar. The lamp is on when the camera output outputs the color bar.

4) Operation of other switches

For the MATRIX ON button, the DTL OFF button, A.KNEE ON button, HIGH COLOR ON button, and the SHT ON button, the ON and OFF states switch every time the button is pressed. The lamp for the DTL OFF button is on when the button is OFF. The lamps for the other buttons are on when the button is on.

Basic operation (Continued)

Operation of the camera using the unit volume

When the lamp of the PANEL ACTIVE button is on, operations of the M.PED volume and the IRIS volume are enabled. When the lamp of the AUTO IRIS button is on, the IRIS volume functions as the volume for setting the target value of the auto iris. When the lamp of the VR ACTIVE button is on, operations of the GAIN volume and the BLACK volume are enabled. In the unit menu, it is possible to select whether the GAIN volume and the BLACK volume are operated in the absolute value mode or the relative value mode.

<Notes>

- In the relative value mode, the value will not change when the volume operation is enabled, but it will change by the amount that the volume turned from the position when the volume operation was enabled. In the absolute value mode, the value will be fixed according to the position of the volume when the volume operation was enabled, and the value for the center click is 0.
- A variable range for the volume can be selected as follows. However, the GAIN setting range covers variations within ± 200 , and the BLACK setting range covers variations within ± 100 , respectively.

Volume variable range

	MIN	NORMAL	MAX
GAIN	100	200	400
BLACK	50	100	200

1) GAIN volume

When the white balance is set using the PRE/A/B button and the auto white balance (AWB) executes, the lamp of the VR ACTIVE button turns off, and the volume operation is disabled.

When executing the AWB, the GAIN set value will be "0" if the AWB OFFSET is set to OFF, while the GAIN set value is retained if the AWB OFFSET is set to ON.

When the relative value mode and the absolute value mode are switched, the lamp of the VR ACTIVE button turns off and the volume operation is disabled. (The GAIN value is unchanged.)

2) BLACK volume

This functions as an adjustment volume for the flare (FLR) or the pedestal (PED) selected in the BLACK-VR-CONTROL on the unit menu.

If the auto black balance (ABB) is executed while the pedestal is selected, the lamp of the VR ACTIVE button turns off, and the volume operation is disabled.

In this case, if the PEDESTAL OFFSET of the camera recorder is set to OFF, the set value will be cleared to 0.

Changes in the VR ACTIVE button when the ABB is executed

VR setting	BLACK-VR-CONTROL	PEDESTAL OFFSET	
		OFF	ON
REL (relative value)	PED	Turned off (disabled)	Turned off (disabled)
	FLR	Retains state	Retains state
ABS (absolute value)	PED	Turned off (disabled)	Turned off (disabled)
	FLR	Retains state	Retains state

Changes in the volume set value when the ABB is executed

VR setting	BLACK-VR-CONTROL	PEDESTAL OFFSET	
		OFF	ON
REL (relative value)	PED	Cleared to 0	Retains
	FLR	Retains	Retains
ABS (absolute value)	PED	Cleared to 0	Retains
	FLR	Retains	Retains

When the BLACK-VR-CONTROL item in the unit menu changes, the lamp of the VR ACTIVE button turns off, and the volume operation is disabled.

If the BLACK-VR-CONTROL is set to "PED", the flare value can be changed in the unit menu but it is impossible to change the pedestal value.

Basic operation (Continued)

3) M.PED volume

When the volume operation is enabled, the unit operates in the absolute value mode where the value is fixed in accordance with the position of the volume. The value will be "0" by clicking the center.

The variable amount is within a range between the minimum value of -200 and the maximum value of +200 with the center value of 0.

Operation of the scene file

The unit has five sets of scene files and is capable to storing the current settings as a scene file or loading the stored settings.

It is also possible to store/call scene files using the SD memory card. For details, refer to "Saving/Loading of scene files onto the SD memory card" (page 21).

1) Operation of the scene file

When the lamp of the RECORDER ENABLE button is off, the scene files are operated using the seven buttons on the top right side of the unit.

Storing: Select a file number to store using buttons 1 to 5 (blue letters). When the button is pressed, the button lamp will flash. If the SAVE (blue letters) button is pressed in this state, the SAVE button lamp will also flash. To store the file, press the SAVE button again. When the store operation is finished, the lamp of the button for the stored file number turns on.

When the lamps for buttons 1 to 5 are flashing, press the button or leave for 10 seconds or more to release the selection.

Loading: Select a file number to load using buttons 1 to 5 (blue letters). When the button is pressed, the button lamp will flash. If the LOAD button is pressed in this state, the selected file will load. At this time, the lamp of the VR ACTIVE button flashes, the operation mode of the volume set in the unit menu is ignored, and the unit is in the relative value mode.

Basic operation (Continued)

<Notes>

- If a scene file is loaded while the volume operation mode is set to the absolute value mode, and then the VR ACTIVE button is operated, the set value will correspond to the volume angle and the loaded value will be lost.

If you want to operate the volume from the value loaded in the scene file, operate the unit while the VR ACTIVE button lamp is flashing or the operation modes of the volumes for WHITE and BLACK are set to the relative value mode before operating the VR ACTIVE button.

- When a scene file is stored or loaded, the button lamps for the file numbers of the files stored or loaded and the LOAD button is turned on. Press the LOAD button to turn the button lamp off. When the camera menu is opened or the scene file data is loaded from the SD memory card, the lamps for both of the File No. button and the LOAD button turn off.
- When the camera menu is open, operations of the scene file are disabled.

2) Items stored in the scene file

Refer to the Menu item Files for storing are checked with a "Yes" Since the same operation applies to storing on the SD memory card, when a scene file stored in a specific unit of the remote controller is used for another unit of the remote controller, load data from the scene file from the specific unit and store on an SD memory card, and then read them out from the card and store them in the scene file of the other unit.

<Note>

Do not turn off the power when a scene file is being stored. Otherwise, data in the scene file may be corrupted.

<Reference>

It is possible to adjust the scene file setting of the unit to the same state as the factory setting for the camera recorder using the following procedure.

However, the settings that cannot be set with the unit cannot be set to the same state.

- 1 Set the settings for the camera recorder to the factory settings. For details, refer to the operation manual of the camera recorder.
- 2 Connect the unit to the camera recorder. Settings for the unit will be imported from the camera recorder.
- 3 Execute RCU-FACTORY on the SYSTEM menu of the unit.
- 4 Store the settings on the unit to scene files 1 to 5 of the unit or an SD memory card.

Operation for recording

If the RECORDER ENABLE button is pressed to switch to the recorder mode, operations of the camera recorder are enabled.

If the REC INH button lamp is on, the REC S/S button on the unit will be inhibited. To start and stop recording, turn off the lamp of the REC INH button by pressing the button, and start and stop recording using the REC S/S button.

<Notes>

- While the REC INH button lamp is on, REC S/S button operations are inhibited.
- If the RECORDER ENABLE button lamp turns off by pressing the button while the recording part is operated, the state of the recording before turning off the lamp is retained and it is possible to operate the scene file built into the unit.
- It is possible to set whether the value adjusted on the unit is retained on the camera recorder or not, by using RC-DATA-SAVE in the FUNC menu of the unit.

Saving/Loading of scene files onto the SD memory card

It is possible to store up to 8 sets of settings for the unit.

While data on the card are read or written, any operation of the unit panel is inhibited. Insert the SD memory card into the SD memory card slot on the unit and operate the unit menu.

<Notes>

- Use an SD memory card with a capacity of 8 MB or more. The maximum capacity of an SD card that can be used on the unit is 2 GB.
- The SD memory card must be formatted on the unit.

Handling methods for the SD memory card

Ensure that the SD memory card is inserted or ejected in the proper direction.

SD memory card slot

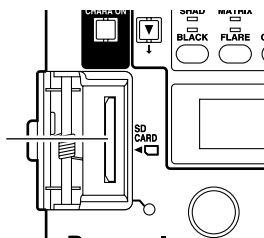

When the SD memory card is used for the first time, execute CARD CONFIG in SYSTEM on the unit menu.

<Note>

While data are being stored on the SD memory card or data are being loaded from the SD memory card, do not remove the SD memory card. Otherwise, data on the SD memory card may be damaged.

To load data from the card

1 When "SYSTEM" is selected using the SHUTTER/SYSTEM button, the indication "CARD-RD" is displayed on the LCD panel together with the value displayed under the indication and the title next to the indication.

2 Select the file to read out by changing the numerical value in the Rotary Encoder 1. If there is no applicable file, the indication "NO FILE" is displayed on the LCD panel.

3 Press the Rotary Encoder 3. When the indication "READ NO?" is displayed on the LCD panel, turn the Rotary Encoder 3 to select "YES?" and press the Rotary Encoder 3 again to start reading out the data.

4 The read operation starts and the indication "ACTIVE" is displayed on the LCD panel. While the data are loaded, the SD memory card access lamp is on.

SD memory card access lamp

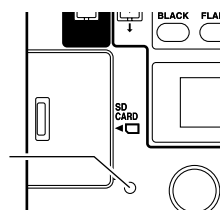

5 When the reading of the data is finished, the SD memory card access lamp turns off and the indication "OK" is displayed on the LCD panel.

<Note>

If the data cannot be read properly, the indication "READ NG" is displayed on the LCD panel. Execute the load operation again. If the load operation is not executed properly, replace the SD memory card with a new one.

Saving/Loading of scene files onto the SD memory card (Continued)

To write data on the card

- 1 Select "SYSTEM" using the SHUTTER/ SYSTEM button, and display the menu on the second layer using the ▼button.
- 2 When the indication "CARD-WR" is displayed on the LCD panel together with the file number displayed under the indication, turn the Rotary Encoder 1 to select the file.
<Note>
If the file already exists, the title is displayed under the TITLE indication. Be careful and do not overwrite the file.
- 3 When the cursor for entering the title is displayed on the LCD panel, turn the Rotary Encoder 3 to select the letters and turn the Rotary Encoder 2 to move the cursor. Up to eight letters can be entered. Once the eighth letter is entered, the last letter will flash.
- 4 When the Rotary Encoder 3 is pressed, the indication "NO?" is displayed on the LCD panel. Turn the Rotary Encoder to select the indication "YES?" and start writing data by pressing the Rotary Encoder 3 again.
- 5 When the writing operation starts, the SD card access lamp is on and the indication "ACTIVE" is displayed on the LCD panel.
- 6 When the writing of the data is finished, the SD memory card access lamp turns off, and the indication "OK" is displayed on the LCD panel.

To delete files from the card

- 1 Select "SYSTEM" using the SHUTTER/ SYSTEM button, and display the menu on the third layer using the ▼button.
- 2 When the indication "CARD-DEL" is displayed on the LCD panel together with the file number displayed under the indication, turn the Rotary Encoder 1 to select the file to be deleted.
- 3 When the Rotary Encoder 3 is pressed, the indication "NO?" is displayed on the LCD panel. Turn the Rotary Encoder 3 to select the indication "YES?" and start deleting data by pressing the Rotary Encoder 3 again.
- 4 When the deleting operation starts, the SD card access lamp is on, and the indication "ACTIVE" is displayed on the LCD panel.
- 5 When the deletion of the data is finished, the SD memory card access lamp turns off, and the indication "OK" is displayed on the LCD panel.

Initialization of the card

- 1 Select "SYSTEM" using the SHUTTER/ SYSTEM button, and display the menu on the fourth layer using the ▼button. The indication "EXEC" is displayed.
- 2 When the Rotary Encoder 3 is pressed, the indication "NO?" is displayed on the LCD panel. Turn the Rotary Encoder 3 to select the indication "YES?" and start the initialization by pressing the Rotary Encoder 3 again.

The following procedures are the same as procedures 4 and 5 for deleting files from the card.

Menu operation

Operations using the LCD panel

The menu can be adjusted using the Rotary Encoders (1 to 3) after displaying the menu on the LCD panel.

- 1** Press one of the following buttons: BLACK/SHAD button, FLARE/MATRIX button, GAMMA/DTL button, WHITE/SKINDTL button, or KNEE/FUNC button to select an item on the menu.
- 2** The indication will switch to the item under the panel → the item on the panel → the state before entering the menu mode → the item under the panel step by step every time the button is pressed.
The LED indicating the selected item is on and the first layer of the menu for the selected item is displayed on the LCD panel.
- 3** Move the layer on the menu using the ▼ button or ▲ button. (Indications are not looped.)
- 4** Adjust the value of the sub-items on the menu using the rotary encoder. The numerical values are increased by turning the rotary encoder clockwise and reduced by turning it counterclockwise.
Depending on the layers, 1 to 3 sub-items are displayed on the LCD panel.
(In some layers, it is necessary to press the rotary encoder3)
- 5** When the camera menu is open, the menu displayed on the LCD panel of the unit is closed, "CAMERA MENU OPEN" is displayed.

Operation of the camera recorder menu

With the unit, it is possible to set the menu of the camera recorder by checking the monitor. Use this feature to set any items that are not included in the unit menu.

- 1** Connect the VIDEO OUT connector of the unit to the monitor.
- 2** Press the MENU ON button for 3 seconds or longer.
The menu of the camera recorder is displayed on the monitor.
<Note>
When the lamp of the CHARA ON button is off, the menu is not displayed on the monitor.
- 3** Operate the menu by operating the Rotary Encoder 3 in the same way as the JOG dial on the main unit of the camera recorder.

<Note>

Significant items such as frame frequency etc., cannot be changed from the unit. In this case, these items can be changed from the camera recorder.

For details such as menu items and setting methods, refer to the operation manual of the camera recorder.

Adjustment of functions on the unit

It is possible to adjust the sound heard when a button on the unit is pressed and the brightness of the LCD panel button by using the menu of the unit. For details, refer to "SYSTEM" (page 31).

Menu item

Menu

The menu items on the unit may vary with the camera recorder connected to the unit.

For the following menu items, the factory settings for the unit only are set separately from the camera recorder.

- ◆ BLACK-VR-CONTROL, BLACK-VR-MODE, and BLACK-VR-RANGE in "BLACK"
- ◆ GAIN-VR-MODE and GAIN-VR-RANGE in "WHITE"
- ◆ BUZZER, LCD CONTRAST, and SW BRIGHT in "SYSTEM"

When the column of "Storage" in the menu table is answered with "Yes", the settings for the relevant items can be stored on the unit or the SD memory card as a scene file. For details, refer to "Operation of the scene file" (page 19) and "Saving/Loading of scene files onto the SD memory card" (page 21).

BLACK

Layer	Item	Variable range	Contents description	Storage
1	RPED	-100 : +100	To set the pedestal for Rch	Yes
	GPED	-100 : +100	To set the pedestal for Gch	Yes
	BPED	-100 : +100	To set the pedestal for Bch	Yes
2	BLACK-VR-CONTROL	FLR PED	To select the items to be adjusted using the BLACK volume FLR: FLARE PED: PEDESTAL	Yes
3	BLACK-VR-MODE	ABS REL	To select whether the BLACK volume of the RGB is operated using the absolute value or the relative value ABS: Absolute value REL: Relative value	Yes
4	BLACK-VR-RANGE	MIN NORM MAX	To switch the variable range of the BLACK volume of RGB MIN: ±25 NORM: ±50 MAX: ±100	Yes

<Note>

When "PED" is selected in the BLACK-VR-CONTROL and the lamp of the VR ACTIVE button is on or "ABS" (absolute value) is selected in the BLACK-VR-MODE item, it is impossible to adjust the PRED/GPEG/BPEG items using the rotary encoder. Adjust these items using the BLACK volume.

_____ is the factory setting mode.

Menu item (Continued)

FLARE

Layer	Item	Variable range	Contents description	Storage
1	RFLAR	-100 : +100	To set the flare for Rch	Yes
	GFLAR	-100 : +100	To set the flare for Gch	Yes
	BFLAR	-100 : +100	To set the flare for Bch	Yes
2	FLAR-CORRECT	ON OFF	To set ON/OFF of the flare correction	Yes

<Note>

When the BLACK volume is assigned for flare adjustment, it must be set in BLACK-VR-CONTROL, BLACK-VR-MODE, and BLACK-VR-RANGE. When "FLR" is selected in the BLACK-VR-CONTROL item, the flare can be adjusted by using the BLACK volume. Switching between the absolute value mode and the relative value mode of the volume can be set in the BLACK-VR-MODE item, while switching of the variable range can be set in the BLACK-VR-RANGE item. When the absolute value is selected in the BLACK-VR-MODE item or the lamp of the VR-ACTIVE button is turned on, R FLAR/G FLAR/B FLAR items cannot be adjusted using the rotary encoder. They must be adjusted with the BLACK volume.

GAMMA

Layer	Item	Variable range	Contents description	Storage
1	RGAM	-15 : +15	To set the gamma for Rch	Yes
	MGAM	0.30 : 0.75	To set the master gamma	Yes
	BGAM	-15 : +15	To set the gamma for Bch	Yes
2	GAMMA-MODE-SEL	HD SD F-LIKE1 F-LIKE2 F-LIKE3	To select the gamma	Yes
3	GAMMA-CORRECT	ON OFF	To set ON/OFF of the gamma correction	Yes

WHITE

Layer	Item	Variable range	Contents description	Storage
1	RGAIN	-200 : +200	To set the Rch gain	Yes
	BGAIN	-200 : +200	To set the Bch gain	Yes
2	FILTER-INH	ON OFF	To select whether the filter has data for the AWB memory (Ach, Bch) or not, for the respective filters independently ON: Data are held in two memory locations (Ach, Bch) regardless of the filter. OFF: The respective filters hold data.	Yes
3	SKLS-AWB	OFF FAST NORMAL SLOW1 SLOW2 SLOW3	To turn on the shockless AWB (FAST/NORMAL/SLOW1/SLOW2/SLOW3)	Yes
	AWBAREA	25% 50% 90%	To switch the AWB detection area	Yes
4	GAIN-VR-MODE	ABS REL	To select whether the GAIN volumes for R and B are operated using the absolute value or the relative value ABS: Absolute value REL: Relative value	Yes
5	GAIN-VR-RANGE	MIN NORM MAX	To switch the variable range of the GAIN volumes for R and B MIN: ±50 NORM: ±100 MAX: ±200	Yes

<Note>

When the absolute value is selected in the GAIN-VR-MODE item, or the lamp of the VR ACTIVE button is turned on, the R GAIN/G GAIN items cannot be adjusted using the rotary encoder. They must be adjusted using the GAIN volume.

_____ is the factory setting mode.

Menu item (Continued)

WHITE (Continued)

Layer	Item	Variable range	Contents description	Storage
6	COLR-TEMP-PRE	2300k : 8000k	To set the color temperature in the AWB PRE	No
7	AWB-A	MEM	To set the position of the WHITE BAL switch and the assignment of Ach MEM: This assigns the memory value when the AWB is executed.	Yes
	TEMP-A	2300k : 8000k	To set the position of the WHITE BAL switch and the color temperature in case of Ach The step varies with the camera conditions.	No
8	AWB-A-GAIN-OFST	ON OFF	ON: Even if the AWB is executed, the set value for the GAIN OFFSET of the AWB-A will not be reset. OFF: When the AWB is executed, the set value for the GAIN OFFSET of the AWB-A will be reset.	Yes

Layer	Item	Variable range	Contents description	Storage
9	AWB-B	MEM	To set the position of the WHITE BAL switch and the assignment of Bch MEM: This assigns the memory value when the AWB is executed.	Yes
	TEMP-B	2300k : 8000k	To set the position of the WHITE BAL switch and the color temperature in case of Bch The step varies with the camera conditions.	No
10	AWB-B-GAIN-OFST	ON OFF	ON: Even if the AWB is executed, the set value for the GAIN OFFSET of the AWB-B will not be reset. OFF: When the AWB is executed, the set value for the GAIN OFFSET of the AWB-B will be reset.	Yes

Menu item (Continued)

KNEE

Layer	Item	Variable range	Contents description	Storage
1	M-KNEE	ON OFF	To set the mode when the AUTO KNEE switch is off ON: MANUAL KNEE OFF: KNEE OFF	Yes
2	MKNPNT	70.0% : 107.0%	To set the position of the MANUAL KNEE POINT by 0.5% step	Yes
	MKNSLP	00 : 99	To set the tilt angle of the MANUAL KNEE	Yes
3	WCLIP	ON OFF	To set ON/OFF of the WHITE CLIP function	Yes
	WCLIPLVL	90% : 109%	To set the WHITE CLIP LEVEL	
4	AKNP	80% : 107%	To set the position of the AUTO KNEE POINT by 1% step	Yes
	AKLV	100 : 109	To set the AUTO KNEE LEVEL	
	AKRESP	1 : 8	To set the AUTO KNEE response speed	

SHUTTER

Layer	Item	Variable range	Contents description	Storage
1	MODE	FIX S.S	To select whether the shutter setting for SHUTTER ON is set to the fixed mode or the synchro-scan mode FIX: Fixed shutter S.S: Synchro-scan	Yes
	SPED	1/60 1/100 1/120 1/250 1/1000 1/2000 HALF	To select the shutter speed The selected speed type (for the fixed shutter, for the synchro-scan) varies with the mode.	Yes
	ACTION	ON OFF	To display conditions of the shutter (Display only)	No

Menu item (Continued)

SHAD

Layer	Item	Variable range	Contents description	Storage
1	B-SHD	ON OFF	To select the black shading ON/OFF	Yes
	DETECT	EXEC	To activate the auto black shading adjustment	No
2	W-SHD	ON OFF	To select the white shading ON/OFF	Yes
3	HSAW (W-R)	-255 : +255	To adjust the R-H-SAW white shading Every NORM and EXTENDER has respective values.	Yes
	HPAR (W-R)	-255 : +255	To adjust the R-H-PARA white shading	
4	VSAW (W-R)	-255 : +255	To adjust the R-V-SAW white shading	Yes
	VPAR (W-R)	-255 : +255	To adjust the R-V-PARA white shading	
5	HSAW (W-G)	-255 : +255	To adjust the G-H-SAW white shading	Yes
	HPAR (W-G)	-255 : +255	To adjust the G-H-PARA white shading	
6	VSAW (W-G)	-255 : +255	To adjust the G-V-SAW white shading	Yes
	VPAR (W-G)	-255 : +255	To adjust the G-V-PARA white shading	
7	HSAW (W-B)	-255 : +255	To adjust the B-H-SAW white shading	Yes
	HPAR (W-B)	-255 : +255	To adjust the B-H-PARA white shading	
8	VSAW (W-B)	-255 : +255	To adjust the B-V-SAW white shading	Yes
	VPAR (W-B)	-255 : +255	To adjust the B-V-PARA white shading	

MATRIX

Layer	Item	Variable range	Contents description	Storage
1	TABL	A B	To select the table for the matrix color correction in case of the MATRIX ON and one to be set on the unit.	Yes
	C-CORCT	ON OFF	To select ON/OFF for the 12-axis color correction	
2	R-G	-63 : +63	To adjust the matrix color of R-G It will be switched using the TABL A/B.	Yes
	R-B	-63 : +63	To adjust the matrix color of R-B	
3	G-R	-63 : +63	To adjust the matrix color of G-R	Yes
	G-B	-63 : +63	To adjust the matrix color of G-B	
4	B-R	-63 : +63	To adjust the matrix color of B-R	Yes
	B-G	-63 : +63	To adjust the matrix color of B-G	
5	C-COR	R R-Mg Mg Mg-B B B-Cy Cy Cy-G G G-YI YI YI-R	To select the color correction axis to be adjusted in the 12-axis color correction	Yes
	SATU	-63 : +63	To adjust the saturation of the color correction axis selected in the C-COR.	
	PHASE	-63 : +63	To adjust the color phase of the color correction axis selected in the C-COR.	

<Note>

For the adjustment of the shading, the adjusted setting on the unit will be retained in the main unit of the camera recorder regardless of the ON/OFF setting on the RC-DATA-SAVE item.

Menu item (Continued)

DTL

Layer	Item	Variable range	Contents description	Storage
1	MDTL	-31 : +31	To set the level of the master detail (H and V)	Yes
	HDTL	0 : 63	To set the H.DTL LEVEL	
	VDTL	0 : 31	To set the V.DTL LEVEL	
2	CORG	OFF 0 : 5	To set detailed noise elimination level	Yes
	FREQ	0 : 31	To set the H.DTL FREQ	
	LDP	0 : 5	To set the LEVEL DEPEND	
3	K-AP	OFF 0 : 5	To set the details of the high brightness part	Yes
	+GAIN	-31 : +31	To change the level in the + direction of the H.DTL	
	-GAIN	-31 : +31	To change the level in the - (down) direction of the H.DTL	
4	CLIP	0 : 63	To change the clip in the + direction of the DTL signals	Yes
	SOURCE	R+G G+B 2G+R+B 3G+R R G	To set the signal source of the DTL signal components	

SKIN DTL

Layer	Item	Variable range	Contents description	Storage
1	S DTL	OFF A B AB	To select the skin tone table that enables skin tone details OFF: To select OFF of the skin color DTL A: To put DTL in the SKINTONE setting set in Table A B: To put DTL in the SKINTONE setting set in Table B AB: To put DTL in the SKINTONE setting set in Tables A and B	Yes
	OUTPUT	MONI VIDEO	To select the output that adds SKINZEBRA	
	SZEB	ON OFF	To select ON/OFF for SKIN ZEBRA against the output selected in OUTPUT The ZEBRA will be attached to the color of the table set in DETECT.	
	2	TABL	A B	
3	SCORG	0 : 7	To set the effects of SKIN TONE DTL scoring	Yes
4	YMAX	0 : 255	To set the maximum value of the brightness signals enabling SKIN TONE	Yes
	YMIN	0 : 255	To set the minimum value of the brightness signals enabling SKIN TONE	

Menu item (Continued)

SKIN DTL (Continued)

Layer	Item	Variable range	Contents description	Storage
5	ICENT	0 : 255	To set the center position on the I-axis (to set the area where SKIN TONE is effective)	Yes
	IWIDTH	0 : 255	To set the width of the area where SKIN TONE on the I-axis with the center position at I CENT is effective	
6	QWIDTH	0 : 255	To set the width of the area where SKIN TONE on the Q-axis with the center position at I CENT is effective	Yes
	QPHASE	-128 : +127	To set the phase of the area where SKIN TONE having a standard on the Q-axis is effective	
7	SKIN-GET	EXEC	This will be used for obtaining the color phase as the target for SKIN TONE DTL	No

FUNC

Layer	Item	Variable range	Contents description	Storage
1	IRISLVL	0 : 100	To set the target value of the auto iris	Yes
	PEAK/AVE	0 : 100	To determine the accounting ratio of the peak against the standard of the auto iris	
2	IRIS-WINDOW	NORM1 NORM2 CENTER	To select the auto iris detection window NORM1: Center of the screen NORM2: Bottom side of the screen CENTR: Spots at the center of the screen	Yes
3	IRISGAIN	CAM LENS	To select whether the iris gain is adjusted on the camera recorder or the lens	Yes
	GAINVAL	1 : 20	To set the IRIS GAIN adjustment value on the camera recorder	
4	USER-SW	USW-M USW-1 USW-2	To select the USER switch where functions will be changed	Yes
	SELECT	INH S/GAIN DS.GAIN LINE MIX S.IRIS I.OVR S.BLK B.GAMMA AUDIO CH1 AUDIO CH2 REC SW Y GET RET SW PRE REC DRS	To select the function to be assigned to the USER button selected in the USER-SW item <Note> When the unit is connected to the camera recorder, the "I.OVR" operation is disabled.	

Menu item (Continued)

FUNC (Continued)

Layer	Item	Variable range	Contents description	Storage
5	BLK-GAMMA	-3 -2 -1 OFF 1 2 3	To set the gamma curve for dark portions	Yes
6	RC-DATA-SAVE	ON OFF	To select whether the value adjusted in the unit will be retained in the main unit of the camera recorder or not, when the unit is removed from the camera recorder When this is set to OFF and the unit is removed, the settings for the camera recorder will return to the state before connecting the unit.	Yes

SYSTEM

Layer	Item	Variable range	Contents description	Storage
1	CARD-READ	1 : 8	To select the file number to be read out	No
	TITLE	***** ***	To read out the title applied to the data of the file to be read out, and display it	
2	CARD-WRITE	1 : 8	To select the file number to be written	No
	TITLE	***** ***	To enter the title applied to the data of the file to be written	
3	CARD-DELETE	1 : 8	To select the file number to be deleted	No
	TITLE	***** ***	To read the title applied to the data of the file to be deleted, and display it	
4	CARD-CONFIG		To configure the card	No
5	BUZZER	ON OFF	To select whether the buzzer is turned on when the switch for the lamp to turn on is pressed	No
6	LCD CONTRAST	0 : 10 : 15	To adjust the contrast of the LCD panel	No
7	SW BRIGHT	0 : 10 : 15	To adjust the brightness of the lamp for the switch	No
8	RCU-FACTRY		To return the volume variable range of the unit to the factory settings	No
9	VERSION		To display the version of the software for the unit	No

_____ is the factory setting

Connection cable

A 10 m connection cable is attached to the unit. To extend the cable, use the optional dedicated cable. If several 10 m cables are connected in tandem, the power supply may be unstable due to voltage drops etc.

In an emergency, apply a higher voltage within a range from 11 V to 17 V for the power supply of DC 12 V to the camera recorder. If the input voltage to the unit is 8 V or less, operation becomes unstable. Refer to the following. A twisted-pair cable must be used for the control line of the 10-pin cable. Attenuation of the coaxial cable must be set to around -6 dB at maximum in 10 MHz.

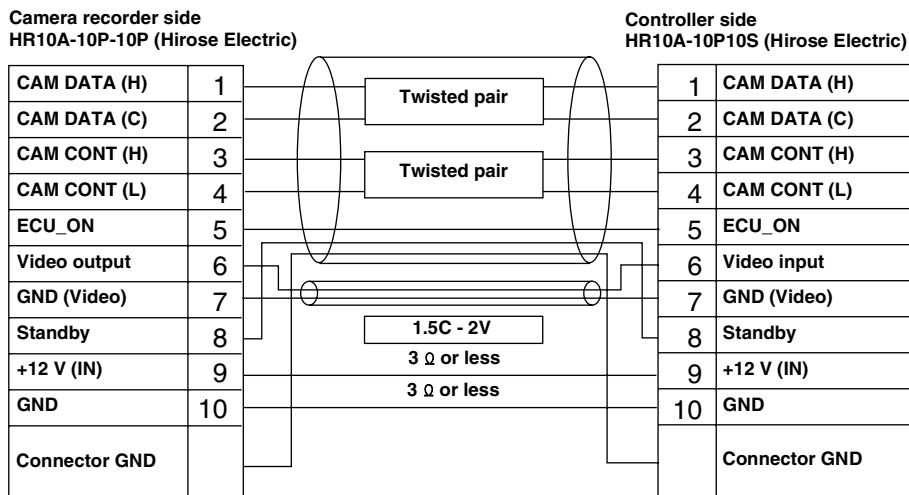

Confirmation of software version

The software version for this unit can be confirmed in "VERSION" under SYSTEM in the unit menu. Confirm for questions.

Specifications

Power supply: DC 12 V

Power consumption: 6 W

 indicates safety items.

External dimensions (W × H × D)

185 mm × 131 mm × 60 mm

(7-5/16 inches × 5-3/16 inches ×

2-5/8 inches)

Weight

1.3 kg (2.87 lb)

Operating temperature

0 °C to +40 °C (32 °F to 104 °F)

Storage temperature

-20 °C to +60 °C (-4 °F to 140 °F)

Maximum cable length

50 m

[Input/Output]

CAMERA

10-pin multi-connector × 1

MONITOR

BNC × 1, 1 VP-P (for menu setting)

Please note that specifications and appearance are subject to change, for improvement purpose, without notice.

Information on Disposal for Users of Waste Electrical & Electronic Equipment (private households)



This symbol on the products and/or accompanying documents means that used electrical and electronic products should not be mixed with general household waste.

For proper treatment, recovery and recycling, please take these products to designated collection points, where they will be accepted on a free of charge basis. Alternatively, in some countries you may be able to return your products to your local retailer upon the purchase of an equivalent new product.

Disposing of this product correctly will help to save valuable resources and prevent any potential negative effects on human health and the environment which could otherwise arise from inappropriate waste handling. Please contact your local authority for further details of your nearest designated collection point.

Penalties may be applicable for incorrect disposal of this waste, in accordance with national legislation.

For business users in the European Union

If you wish to discard electrical and electronic equipment, please contact your dealer or supplier for further information.

Information on Disposal in other Countries outside the European Union

This symbol is only valid in the European Union.

If you wish to discard this product, please contact your local authorities or dealer and ask for the correct method of disposal.

Panasonic®

PANASONIC BROADCAST & TELEVISION SYSTEMS COMPANY
UNIT COMPANY OF PANASONIC CORPORATION OF NORTH AMERICA

Executive Office:

One Panasonic Way 4E-7, Secaucus, NJ 07094 (201) 348-7000

EASTERN ZONE:

One Panasonic Way 4E-7, Secaucus, NJ 07094 (201) 348-7196

Southeast Region: (201) 348-7162

WESTERN ZONE:

3330 Cahuenga Blvd W., Los Angeles, CA 90068 (323) 436-3500

Government Marketing Department:

One Panasonic Way 2E-10, Secaucus, NJ 07094 (201) 348-7587

Broadcast PARTS INFORMATION & ORDERING:

9:00 a.m. – 5:00 p.m. (EST) (800) 334-4881/24 Hr. Fax (800) 334-4880

Emergency after hour parts orders (800) 334-4881

TECHNICAL SUPPORT:

Emergency 24 Hour Service (800) 222-0741

Panasonic Canada Inc.

5770 Ambler Drive, Mississauga, Ontario L4W 2T3 (905) 624-5010

Panasonic de Mexico S.A. de C.V.

Av angel Urraza Num. 1209 Col. de Valle 03100 Mexico, D.F. (52) 1 951 2127

Panasonic Puerto Rico Inc.

San Gabriel Industrial Park, 65th Infantry Ave., Km. 9.5, Carolina, Puerto Rico 00630 (787) 750-4300

Professional & Broadcast IT Systems Business Unit Europe
Panasonic Marketing Europe GmbH

Hagenauer Str. 43, 65203 Wiesbaden-Biebrich Deutschland Tel: 49-611-235-481

松下电器产业株式会社

Web Site: <http://panasonic.net>

松下電器産業株式会社 システム事業グループ

〒 571-8503 大阪府門真市松葉町 2 番 15 号 ☎ (06) 6901-1161